

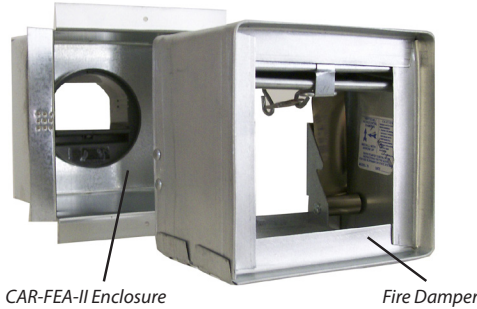

AIRFLOW & ZONE CONTROLS  
**CAR-FEA-II**  
 Constant Airflow Regulator with Integral Fire  
 Damper for Exhaust or Return Air Applications

PRODUCT  
 SPECIFICATIONS  
 & TECHNICAL  
 DATA



**MAINTENANCE**

The CAR-II needs no maintenance when used in normal conditions. There is no risk of dust deposit or obstruction because the CAR-II has no airways subject to clogging. If the intended application includes air heavily loaded with grease or dust, a fitting with an access panel or door, such as that used for flame dampers, should be provided.

**WARRANTY**

Guaranteed for 5 years, from date of shipment, against all defects in material or workmanship, provided that the material has been installed and utilized under normal conditions. This warranty is limited to the repair or replacement of the material.

**GENERAL**

The model CAR-FEA-II Constant Airflow Regulator is a modulating orifice that automatically regulates airflows in duct systems to constant levels. The passive control element responds to duct pressure and requires no electric or pneumatic sensors or controls.

The CAR-FEA-II compensates for changes in duct pressure caused by thermal stack effect, building pressure, dust-clogged filters, etc. The CAR-FEA-II also provides a low-cost solution to balancing forced-air systems for heating, air conditioning, and ventilation, eliminating the need for on-site balancing. The CAR-FEA-II will regulate airflow in exhaust or return air duct systems.

The active control element of the CAR-FEA-II is a unique aerofoil (CAR-II). Using Bernoulli's Principle, the aero-wing damper lifts in response to increasing static pressure. This operation regulates the free-area opening through the control, resulting in maintenance of velocity and specific airflow set points. Each CAR-II is designed and produced for control of air in temperatures ranging from -25° to 140°F (-32° to 60 °C.)

**CONSTRUCTION**

The CAR-FEA is safety classified to UL 2043. The CAR-II is mounted in a heavy-gauge galvanized steel enclosure designed to accommodate installation of curtain-type fire dampers. The fire damper is tested and listed per UL555 for use in wall or shaft applications, and it is intended to be installed in a fire partition that is rated up to 2 hours. Three-hour fire dampers may also be used. Each enclosure is welded to prevent leakage. The assembly is sized to fit inside standard duct riser openings and chases. Each sleeve is designed to specifically accommodate the control element and prevent unwanted air leakage.

**PERFORMANCE**

The CAR-II controls airflow accurately to within 10% of rated flow (15% for units 50 CFM or less) throughout the target operating pressure range of 0.2 to 0.8 in. w.g. (50 to 200 Pa). Each CAR-II is factory tested and calibrated to the rated set point before shipping. On-site field adjustment of airflow set points can be made for supply air applications (contact factory). Each CAR-II register is available in multiple factory-calibrated set points (see performance curves).

**CAR-FEA-II Dimensions**

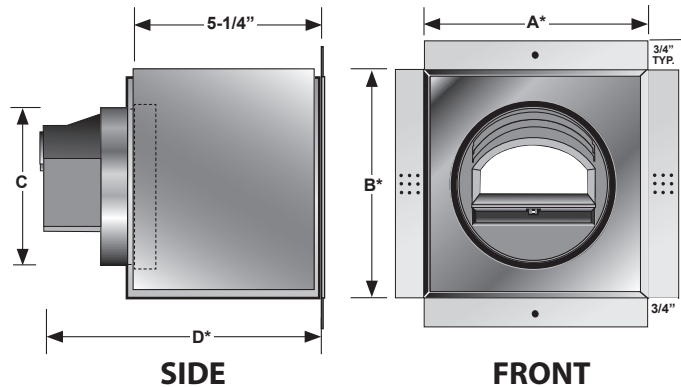

PART NUMBER	SLEEVE SIZE (NOMINAL)	CAR-II (NOMINAL)	A*	B*	C	D*
18 862	6" x 6"	4"	5.6"	5.6"	3.5"	7.1"
18 863	6" x 6"	5"	5.6"	5.6"	4.5"	8.2"
18 864	6" x 6"	6"	5.6"	5.6"	5.4"	8.2"
18 865	8" x 8"	4"	7.6"	7.6"	3.5"	7.1"
18 866	8" x 8"	5"	7.6"	7.6"	4.5"	8.2"
18 867	8" x 8"	6"	7.6"	7.6"	5.4"	8.2"
18 868	8" x 8"	8"	7.6"	7.6"	7.3"	7.9"
18 869	10" x 10"	4"	9.6"	9.6"	3.5"	7.1"
18 870	10" x 10"	5"	9.6"	9.6"	4.5"	8.2"
18 871	10" x 10"	6"	9.6"	9.6"	5.4"	8.2"
18 872	10" x 10"	8"	9.6"	9.6"	7.3"	7.9"
18 873	10" x 10"	10"	9.6"	9.6"	9.3"	8.3"
18 874	12" x 12"	4"	11.6"	11.6"	3.5"	7.1"
18 875	12" x 12"	5"	11.6"	11.6"	4.5"	8.2"
18 876	12" x 12"	6"	11.6"	11.6"	5.4"	8.2"
18 877	12" x 12"	8"	11.6"	11.6"	7.3"	7.9"
18 878	12" x 12"	10"	11.6"	11.6"	9.3"	8.3"

\* Standard sizes shown. Sleeve assemblies are also available to accommodate any damper and grille size. Contact factory.

## How the CAR-II Works

Constant airflow is achieved by controlling the free area through the device. At minimum static pressure, the aero-wing is parallel to the air stream. As the static pressure increases, the aero-wing lifts, reducing the amount of free area through the regulator. At the same time, higher static pressure increases the air velocity resulting in **CONSTANT AIRFLOW**. This occurs regardless of pressure differences in the range of 0.2 to 0.8 in. w.g. (50 to 200 Pa). The air velocity in the duct is in the range of 60 to 700 ft/min. (0.3 to 3.5 m/s).

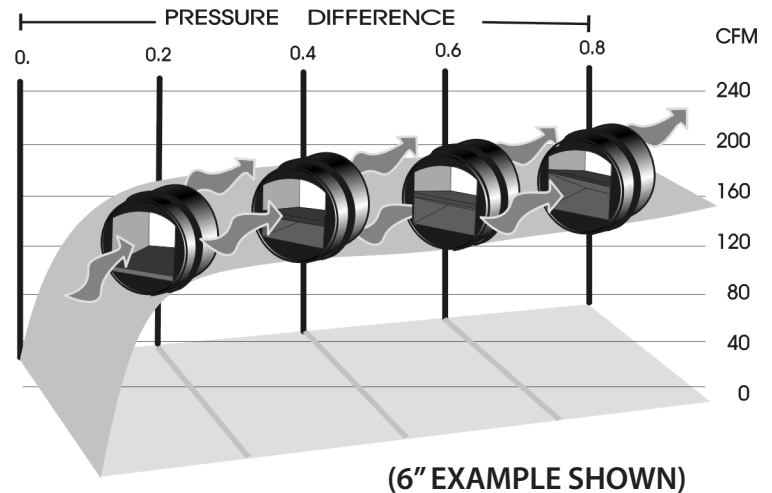

## Typical CAR-FEA-II Applications

- Exhaust air in offices.
- Balancing exhaust airflows in high-rise building duct risers.
- Bathroom exhaust in nursing homes, hotels, motels, dormitories, apartment buildings, offices, etc.
- Balancing exhaust of heat recovery ventilation systems.

## Typical Specification

Model CAR-FEA-II Constant Airflow Regulators by American ALDES Ventilation Corporation, Bradenton, Florida, shall solely operate on duct pressure and require no external power supply. Each regulator shall be pre-set and factory calibrated, requiring no field adjustment to the airflows as indicated on the schedule, and shall be rated for use in air temperatures ranging from -25° to 140°F (-32° to 60°C.)

Constant Airflow Regulators shall be capable of maintaining constant airflow within +/- 10% of scheduled flow rates (15% for units 50 CFM or less), within the operating range of 0.2 to 0.8 in. w.g. differential pressure. Regulators shall be provided as an assembly consisting of a 94V-0 UL ABS plastic body. All regulators must be classified per UL 2043 and carry the UL mark indicating compliance. The Constant Airflow Regulator assembly shall be mounted in a heavy-gauge galvanized steel sleeve with a curtain-type fire damper. The fire damper shall be tested and listed per UL555 for use in wall or shaft applications, and be rated for 2-hour protection. All Constant Airflow Regulators will require no maintenance and must be warranted for a period of no less than five years. Constant Airflow Regulators shall be installed in tight ducting systems in accordance with all applicable codes and manufacturer's instructions.

# CAR-FEA-II Airflow Performance Data

Performance charts reflect airflow measurements taken at 68°F (20°C) at 1 atmosphere pressure. The CAR-FEA-II is designed for system pressures between 0.2 and 0.8 in. w.g.

## 4" DIAMETER (100 mm) REGULATING ELEMENT

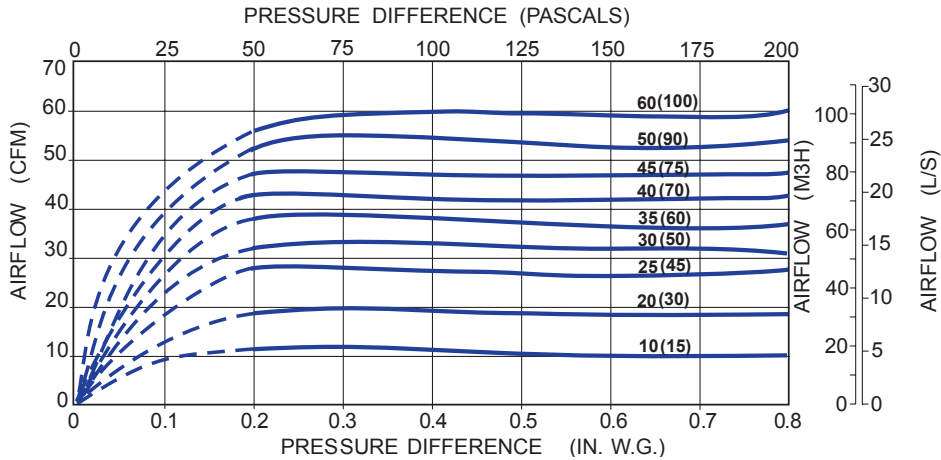

## 5" DIAMETER (125 mm) REGULATING ELEMENT

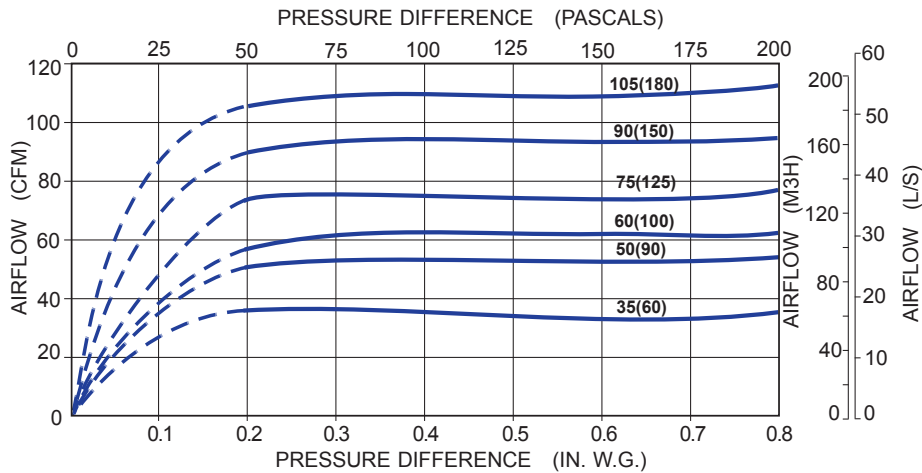

## 6" DIAMETER (150 mm) REGULATING ELEMENT

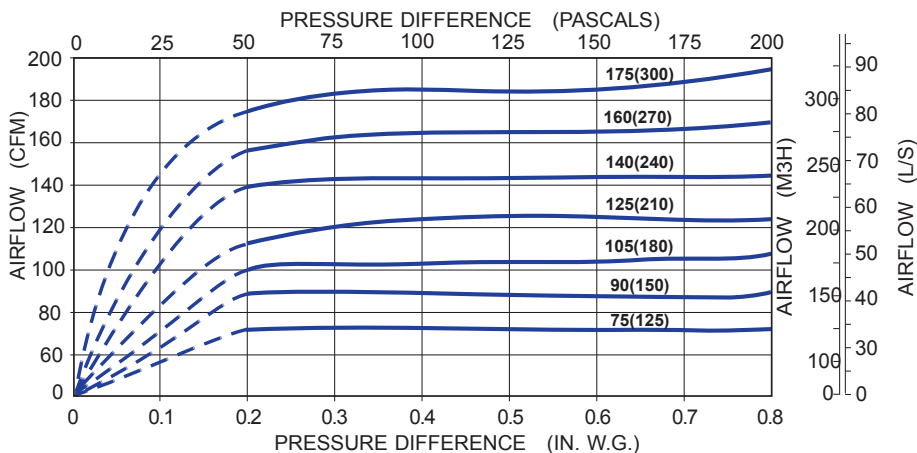

# CAR-FEA-II Airflow Performance Data

Performance charts reflect airflow measurements taken at 68°F (20°C) at 1 atmosphere pressure. The CAR-FEA-II is designed for system pressures between 0.2 and 0.8 in. w.g.

## 8" DIAMETER (200 mm) REGULATING ELEMENT

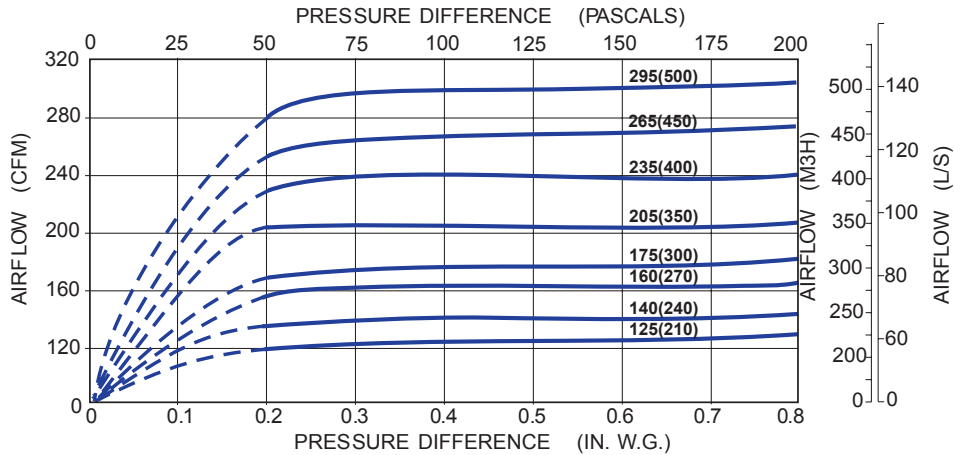

## 10" DIAMETER (250 mm) REGULATING ELEMENT

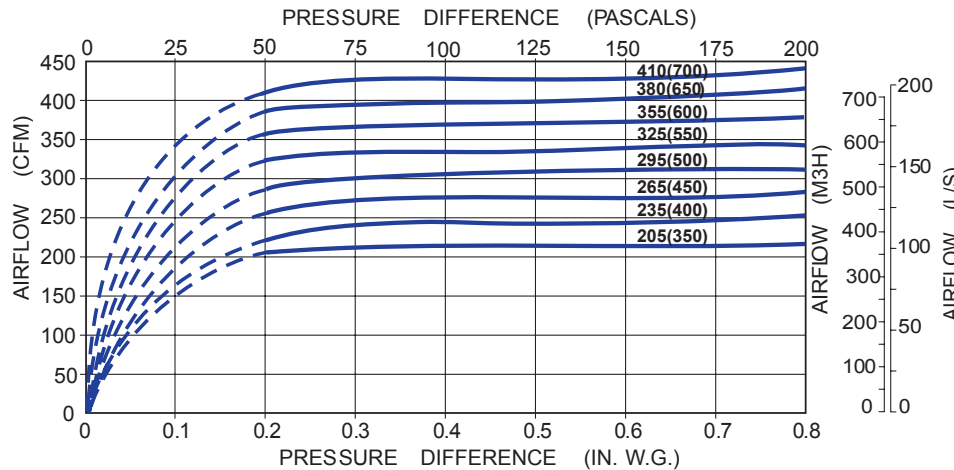

© 2015 American ALDES Ventilation Corporation. Reproduction or distribution, in whole or in part, of this document, in any form or by any means, without the express written consent of American ALDES Ventilation Corporation, is strictly prohibited. The information contained within this document is subject to change without prior written notice.